

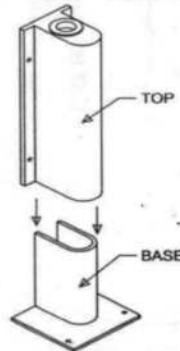

Puertas & Portones Automaticos, S.A. de C.V.  
*¡Nuestra pasión es la Solución!...*

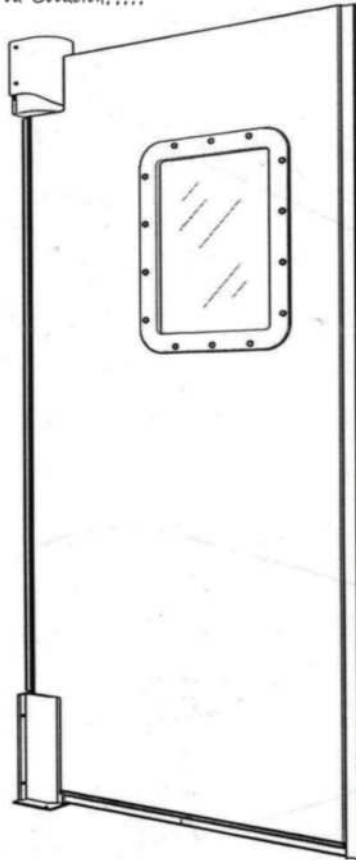

**ADJUSTABLE HINGE GUARD**  
"Aluminum ONLY"  
PART # D05KTADJLH  
QTY:

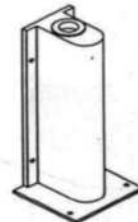

**LOWER HINGE GUARD**  
"Aluminum"  
PART # D05ASHGRTC  
QTY:

**LOWER HINGE GUARD**  
"Stainless Steel"  
PART # D05AS9090C  
QTY:

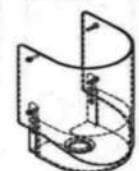

**"NEW STYLE" UPPER HINGE SEAL**  
PART # D05KTHS008 (KIT)  
PART # D05PPHSRAP (SEAL)  
QTY:



**UPPER "V-CAM" HINGE ASSEMBLY**  
("One Piece" Full Composite)  
PART # D05AS55290  
QTY:

(With "HOLD OPEN" Option)  
PART # D05ASRETHO  
QTY:



**ROLLER ASSEMBLY**  
PART # D05AS5508C  
QTY:

**ROLLER ASSEMBLY w/ Stainless Steel Bearing**  
PART # D05AS5508S  
QTY:

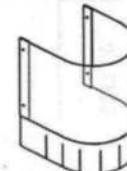

**"OLD STYLE" UPPER HINGE SEAL**  
PART # D0MGS0014  
QTY:



**"V-CAM"**  
(For Extended Opening Heights)  
PART # D05CSRVCPC  
QTY:

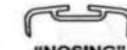

**"NOSING"**  
PVC Gasket Retainer for Back and Bottom Edges of Panel (102" Long)  
PART # D05PP0908E  
QTY:

1/8" Poly, Frame & Fasteners (Front & Back - Single Pane)

Size	Part Number	Qty
8" x 14"	D05KT0814W	
12" x 18"	D0MPK01218	
16" x 16"	D0MPK01616	
17" x 23"	D0MPK01723	

1/8" Poly, Frame & Fasteners (Front & Back - Double Pane)

Size	Part Number	Qty
8" x 14"	Not Available	
12" x 18"	D0MPK1218D	
16" x 16"	D0MPK1616D	
17" x 23"	D0MPK1723D	

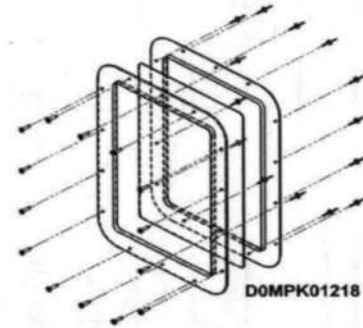

**ADA APPROVED WINDOW KITS**

1/8" Poly, Frame & Fasteners (Front & Back - Single Pane ONLY)

Size	Part Number	Qty
10" x 30" ADA	D05KT1030A	
12" x 30" ADA	D05KT1230A	<input checked="" type="checkbox"/>
16" x 30" ADA	D05KT1630A	
20" x 30" ADA	D05KT2030A	
24" x 30" ADA	D05KT2430A	

**RETAILER GASKETS\***

90" X 90" Hardware Only

Part Number	Durus #	Qty
D05GS01628	1628	
D0MGS00719	1535	
D05GS16779	1677	
D05GS01182	1613	
D0MGS00870	1560	
D0MGS00686	1558	
D07GS01525	1525	
D0NASSTDSW	1557	
D05GS09306	1615	
D0MGS00722	1545	
D0MGS01182	1610	
D0MGS1559F	1559	

\*Standard Gaskets in Bold

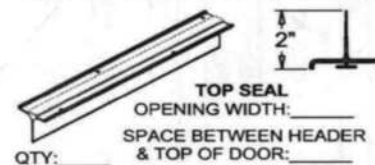

**TOP SEAL**  
OPENING WIDTH:   
SPACE BETWEEN HEADER & TOP OF DOOR:   
QTY:

DURUS PART # 1520 (Std. 2")  
DURUS PART # 1520E (> 2")

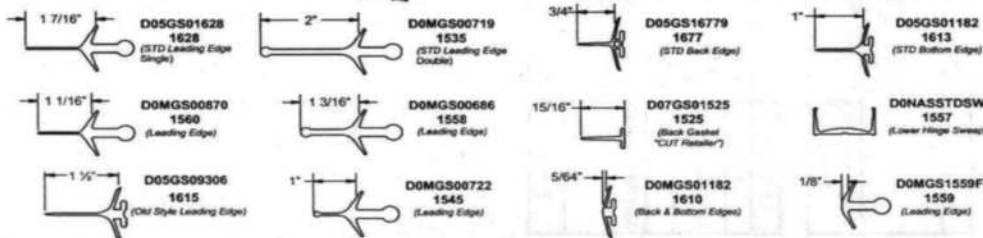

**RETAILER GASKETS**

**DURULITE® RETAILER**  
90" X 90" Hardware Only

PART REPLACEMENT ORDER FORM



V06.18

(229) 365-5662

portonesautomaticos@adsver.com.mx  
portonesautomaticos@prodigy.net.mx



RESIDENCIAL



COMERCIAL



INDUSTRIAL



MEMBER  
**IDA**  
International Door Association